

**DYNAMIK DURCH  
WIDERSTAND**

***DYNAMICS  
THROUGH RESISTANCE***

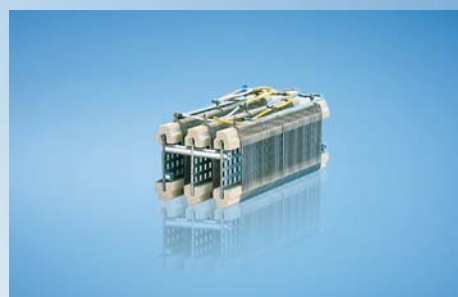

**FRIZLEN**  
LEISTUNGSWIDERSTÄNDE  
POWER RESISTORS

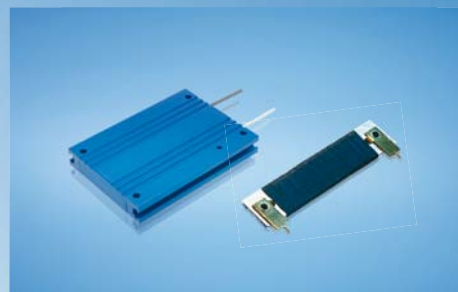

## **DYNAMIK DURCH WIDERSTAND**

**Wir über uns**

## **DYNAMICS THROUGH RESISTANCE**

**About us**

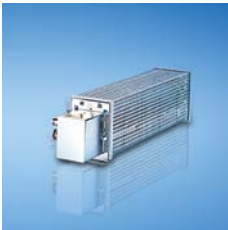

### **DIE KLASSIKER**

**Drahtgewickelte Rohrfestwiderstände**  
10 bis 6000 Watt

### **THE ORIGINAL ONES**

**Wirewound tubular fixed resistors**  
10 up to 6000 Watt



### **DIE FLEXIBLEN**

**Zementierte  
Drahtdrehwiderstände**  
16 bis 1500 Watt

### **THE FLEXIBLE ONES**

**Cement coated wirewound  
variable resistors**  
16 up to 1500 Watt

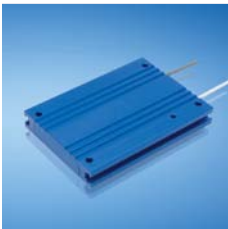

### **DIE INNOVATIVEN**

**Drahtgewickelte Flachwiderstände,  
auch gekapselt und in wassergekühlter  
Ausführung**  
5 bis 40000 Watt

### **THE INNOVATIVE ONES**

**Wirewound flat resistors,  
also enclosed and  
watercooled**  
5 up to 40000 Watt



### **DIE BELASTBAREN**

**Last- und Prüfwiderstände**  
0,01 bis 250 Kilowatt

### **THE LOADABLE ONES**

**Load- and test resistors**  
0.01 up to 250 Kilowatt



### **DIE MODULAREN**

**Drahtgewickelte  
Lamellenfestwiderstände**  
0,15 bis 30 Kilowatt

### **THE MODULAR ONES**

**Wirewound lamina type  
fixed resistors**  
0,15 up to 30 Kilowatt



### **DIE ROBUSTEN**

**Stahlgitterfestwiderstände**  
0,5 bis 250 Kilowatt

### **THE ROBUST ONES**

**Steel-grid fixed resistors**  
0,5 up to 250 Kilowatt



### **FRIZLEN SONDERGERÄTE**

**DC-POWERSWITCH**  
**Kundenspezifische Widerstandsgeräte**

### **FRIZLEN SPECIAL DEVICES**

**DC-POWERSWITCH**  
**Customised resistor units**

## Das richtige Produkt für Ihre Anwendung

## Suitable products for your application

Anwendungen	Application	Typleistung [kW]		Produktgruppe					
		min.	max.	T 100	T 200	T 300	T 400	T 500	T 600
Bremswiderstände für Frequenzumrichter- und Gleichstromantriebe	<i>Braking resistors for frequency converters and DC drives</i>	0,01	40,0			X		X	
		0,01	6,0	X				X	X
		6,0	30,0					X	X
		30,0	250						X
Belastungswiderstände für Spannungsquellen, Batterien, USV-Geräte, Generatoren und Netzgeräte	<i>Load resistors for supply units, power packs, batteries, UPS units and generators</i>	0,01	250				X		
Stufenlose Drehzahlverstellung von kleinen Gleich- und Wechselstrommotoren	<i>Stepless variable speed adjustment for small AC and DC motors</i>	0,01	1,5		X		X		
Feldsteller für Generatoren, Widerstände zur Strom- und Spannungsbegrenzung	<i>Field rheostats for generators, resistors for current and voltage limitation</i>	0,01	3,8	X	X				
Motorische Potentiometer als fernbetätigte Sollwertgeber	<i>Motorised potentiometers as nominal value setters</i>	0,01	1,5		X				
Widerstandsbaugruppen für Einbau in leistungselektronische Geräte	<i>Resistor modules fitting into electronic power devices</i>	0,01	0,75	X		X		X	
		0,3	2,0					X	
Anlass- und Stellwiderstände für Schleifringläufer- und Gleichstrommotoren	<i>Starting and regulating resistors for slip-ring rotor and DC motors</i>	0,15	30,0					X	
		0,5	250						X
Ständer-Vorschaltwiderstände für Kurzschlussläufermotoren	<i>Stator series resistors for squirrel-cage motors</i>	0,5	250						X
Strombegrenzungswiderstände zur Ladung und Entladung von Kondensatoren	<i>Resistors for current limitation e.g. for charging and discharging of capacitors</i>	0,01	1,0	X		X		X	
Experimentier- und Prüfwiderstände in Laboratorien, Schulen und Universitäten	<i>Resistors for experimenting and testing in laboratories, schools and universities</i>	0,01	50				X		
Widerstände zur Schutzbeschaltung, Filterwiderstände	<i>Protective resistors, filter resistors</i>	0,01	0,75	X		X		X	
		0,75	6,0	X				X	
		1,5	22,0						X



## Wir über uns

Mit FRIZLEN Leistungswiderständen haben Sie elektrische Leistung voll im Griff.



Unser umfassendes Know-how zeigt sich im kompletten Spektrum vom Einzelstück bis zur Serie, für Leistungen von 5 Watt bis 250 Kilowatt.



Einsatz- und Anwendungsgebiete stellen die Anforderungen, die Lösungen entwickeln wir.

Ihrem Anforderungsprofil entsprechend berechnen und fertigen wir Widerstände und Widerstandskombinationen unter Berücksichtigung Ihrer Vorgaben. Natürlich beraten wir Sie gern und ermitteln auf Wunsch die Widerstandsdimensionierung mit Hilfe EDV-gestützter Berechnung und Simulation.

Hochwertige Standard- sowie Sonderlösungen von FRIZLEN sorgen für Dynamik im Verbund mit leistungselektronischen Geräten in Maschinen und Anlagen. Bewegung zu stoppen, konstant zu halten und exakte Abläufe zu ermöglichen – dabei unterstützen wir die elektrische Antriebstechnik und verbessern so die Dynamik Ihrer Antriebe.

## About us

*Keep your electric power under control with FRIZLEN power resistors.*

*Our extensive know-how is demonstrated in a complete spectrum from single item up to series production, for power values from 5 watts up to 250 kilowatts.*

*Different ranges of use and application set the requirements, we provide the solutions.*

*We design and produce resistors and resistor combinations exactly to meet your requirements. We are, of course, happy to advise you according to your specification. Upon request, we can determine resistor dimensioning using our computer-supported calculation and simulation system.*

*High-quality standard and special solutions from FRIZLEN ensure dynamics when you are dealing with high performance electrical equipment in machines and processes. We support electrically driven power engineering by stopping movement, keeping it constant and ensuring exact sequences, which improves the dynamics of your drive systems.*

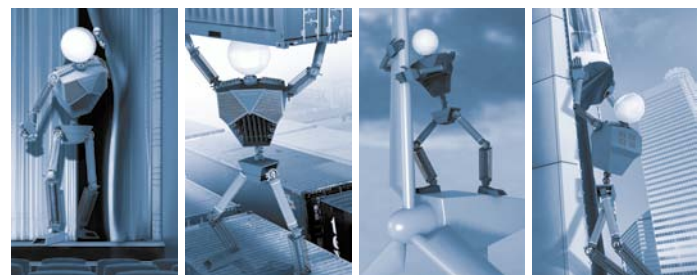





### **Drahtgewickelte Rohrfestwiderstände**

10 bis 6000 Watt

Drahtgewickelte Rohrfestwiderstände, aufgebaut als Einzelrohre, die einbaufähig sind und daraus aufgebaute Rohrfestwiderstandsgeräte in verschiedenen Schutz- und Befestigungsarten.

- In zementierter und unzementierter Ausführung
- Für Anschluss an Löt-, Schraub- oder Flachsteckanschlüssen, mit oder ohne Abgreifschellen
- Widerstandskombinationen bestehend aus einem bis sechs Rohren
- Für Befestigung mit Gewindebolzen, Steckwinkeln oder Stirnblechen in Schutzart IP00
- Mit Gehäuse für waagerechte oder senkrechte Befestigung in Schutzart IP20, Anschluss an Klemmen
- Thermisches Überstromrelais, Temperaturschalter oder FRIZLEN DC-Powerswitch für thermische Überwachung und Abschaltung

### **Wirewound tubular fixed resistors**

10 up to 6000 Watt

Wirewound tubular fixed resistors as individual components, that can be integrated into other units and composed to tubular fixed units in different degrees of protection and mounting types.

- In cemented and uncemented version
- Variable connections at soldering, fast-on or screw clips, with or without adjustable clips
- Units consisting of one to six tubes
- In degree of protection IP00 with threaded rods, fastening brackets or side-panels
- In degree of protection IP20 with enclosure for horizontal and vertical mounting, connection on terminals
- Thermal overload relay, temperature switch or FRIZLEN DC-Powerswitch for thermal monitoring and switch off



## Contents

This list comprises wirewound tubular fixed resistors as individual components in uncemented version FU as well as in cemented version FZ as the standard version. All the components can be integrated into other units. The assembled tubular fixed resistor units are available in different degrees of protection and mounting methods.

<i>maximum power</i>	<i>characteristics</i>	<i>type series</i>	<i>page</i>
	general survey		<b>T102E</b>
	technical details		<b>T103-108E</b>
1000 W	suitable for integration,	FZ/FU, FZB/FUB	<b>T109-110E</b>
44 W	for printed circuit board mounting	FZ...L /FU...L	<b>T111E</b>
300 W	with fastening brackets, loose and/or mounted	FZS /FUW	<b>T112-113E</b>
900 W	for vertical mounting	F..N /F..R /F..P	<b>T114-115E</b>
1000 W	with side-panels	FZ.H /FU.H	<b>T116E</b>
3000 W	with cover	FZ.A.	<b>T117E</b>
3000 W	with cover and terminals	FZ.M.	<b>T118E</b>
6000 W	with cover, terminals in terminal box	FZ.G. / FZ.C	<b>T119-120E</b>
6000 W	with thermal overload relay	FZ.T.	<b>T121E</b>
6000 W	with FRIZLEN DC-POWERSWITCH	FZ.X.	<b>T122E</b>

## Properties

- **low temperature coefficient**  
⇒ constant ohmic value over a large temperature range (s. p. T103E)
- **force locking fixation of wire using cementation**  
⇒ good heat conducting properties
- **variable resistance value adjustable by clips**  
⇒ change and/or adjustment or trimming by the user (s. type series description)
- **various diameters and lengths**  
⇒ can be integrated, various possibilities for connection and mounting
- **enclosures made from hot galvanised steel sheet**  
⇒ various protection and mounting types
- **low-noise and low-induction version available**  
⇒ used for apartment buildings, hospitals, opera houses and theatres
- **thermal overload relay or temperature switch available**  
⇒ integrated warning for high operating security (serialized with series FZ..Q and F..T)
- **intrinsically safe**  
⇒ to switch off the resistor safely by FRIZLEN DC POWERSWITCH
- **UL-recognition for American and Canadian market (E212934)**  
⇒ on request for type series FZ.P., FZ.M., FZ.C and FZ.T..











## Applications

- braking resistors for frequency converters and DC drives, in low-noise version also for hospitals and theatres.
- load resistors for supply units, power packs, batteries, UPS units and generators
- resistors for current and voltage limitation e.g. for charging and discharging of capacitors
- field rheostats for generators
- protection and damping resistors



### T 100 - Survey

type series	characteristics	FZ FU FZB FUB	FZ..x.L + FU..x.L	FZS FUS FZW FUW	F..N F..R F..P	FZ.H + FU.H	FZ.A	FZ.M	FZ.G + FZ.C	FZ.T	FZX
		page symbol	T109E/ T110E	T111E	T112E/ T113E	T114E/ T115E	T116E	T117E	T118E	T119E/ T120E	T121E
	typical power from [W]	12	12	12	12	430	65	65	65	150	300
	typical power up to[W]	1000	44	300	900	3000	3000	3000	6000	6000	6000
	max. terminal / connection # (without adjustable tap and temperature switch)	2	2	2	6	2	2	2	2	2	2
	degree of protection IP00	IP 00	X	X	X		X				
	degree of protection IP20 - if mounted on an appropriate surface	IP 20 <sup>①</sup>						X	X	X	X
	degree of protection IP20 terminals protected against contact	IP 20 <sup>②</sup>				X		X			
	integration possible	E	X	X	X		X				
	horizontal mounting							X	X	X	X
	vertical mounting							X	X	X	X
	vertical mounting on mounting sheet					X					
	thermal overload relay									X	
	adjustable clip available		X		X	X	X	X			
	temperature switch (optional)		X		X	X	X	X	X		
	FRIZLEN DC-POWERSWITCH										X
	with  recognition					X (only FZ.P)		X	X (only FZ.C)	X	

Rights for improvements and modifications of our products reserved.  
Modifications, errors and misprints justify no claim for damages.  
We refer to our terms of sales and delivery.



## Technical details

### *Construction*

The basis are high quality ceramic or porcelain tubes with diameters of 16, 24, 35, 45 and 65 mm. We use round wires or bands that are made from various alloys, but mainly from CuNi 44 according to DIN 17471, 46460-1 and 46461 or NiCr 3020 and/or CrAl 25 5 according to DIN 17470.

### *Type series FZ..*

Above mentioned wires are wound with pitch and are used for cement coated fixed and adjustable resistors. (FZ..) Then they are fixed by a special cement coat. The selection of a tubular fixed resistor for continuous dissipation is only determined by the size of the surface, that means the size of tube, and by the maximum allowable temperature on the surface. We highly recommend this construction type for all standard applications as well as for short time operations with braking resistors.

### *Type series FU..*

If a very high short time power should be dissipated on the smallest possible surface, this energy must be absorbed by the weight of the resistance material within the first second. For producing our uncemented tubular resistors we wind an oxidized wire without gap. Its oxidation functions as insulation. The wire is not protected by a cement coat. If you compare this type to the cemented one you will reach much higher wire weights on the very same surface. Therefore this version is constructed for a very high, not pulsating amount of energy during a short time, like during charging or discharging of capacitors. You will pick this version when you are dealing with single switching operations.

For slide resistors, please look at our technical list T400E.

### *Resistance values/ Production tolerance/ Temperature dependency*

The resistance values in the column "production range" refer to our standard production range and appear in row E12\*. Please select from there. Different values upon request. The normal tolerance is  $\pm 10\%$ . Smaller tolerances upon request. The resistance value will change slightly in dependency of the winding temperature. With  $\Delta T \approx 300$  K the resistance will change compared to a cooled down condition as follows: with wires made of CuNi 44 approx.  $\pm 1\%$ , made of CrAl 25 5 approx.  $+1\%$  and made of NiCr 3020 approx.  $+10\%$ . We select the alloys corresponding to the resistance values or to demand. You will find indications concerning temperatures on page T105E and T106E.

### *Preferred ohmic values*

\*E12: multiplication or division by integer potencies of 10 with the following values:  
1,0 - 1,2 - 1,5 - 1,8 - 2,2 - 2,7 - 3,3 - 3,9 - 4,7 - 5,6 - 6,8 - 8,2

### *Time constant*

The average thermal time constant is 300 s.

### *Adjustable clips*



Tubular fixed resistors of different type series can be flexibly equipped with adjustable clips to adapt the resistance values (compare e.g. page T109E, T111E-114E, T116E and T117E). The clips may only be adjusted in a condition free of voltage and after sufficient loosening and cooling. All our adjustable clips are equipped with silver contacts. When selecting please consider that the maximum temperature on the surface should not exceed 300°C. Please mind the details on pages T106E and T107E, too.





### Degrees of protection

IP 00
IP 20 <sup>①</sup>
IP 20 <sup>②</sup>

Correlation of type series and degrees of protection according to EN 60529 and/or DIN VDE 0470 part 1

Type series	Degree of protection	First digit degree of protection against access & solid foreign objects	Second digit degree of protection against water
FZ., FU. F.S., F.W., F.H.	IP 00	Non-protected – i.e. depending upon integration the user must provide a protection	Non-protected
F..A, F..C, F..G, F..M, F..T. F..X	IP 20 <sup>①</sup>	Protected against access to hazardous parts with a finger and against solid foreign objects of 12,5mm Ø and greater.	Non-protected
F..N, F..R, F..P	IP 20 <sup>②</sup>		Non-protected

<sup>①</sup> if mounted on an appropriate surface – i.e. mounted on a surface according to degree of protection IP 20 or higher

<sup>②</sup> Terminals are protected against access to hazardous parts according to BGV A2

### Air and creepage distances

Air and creepage distances are rated according to IEC 664 (DIN EN 0110 part 1) for the overvoltage category III and degree of pollution 3 for grounded three-phase mains supplies up to 3 x 500 V. Testing voltage 2.5 kV AC.

These data are valid for all devices that are connected to mains voltage and derived voltages, as for example the intermediate circuit voltage of frequency converters.

Do not conclude from the calculated relation between the rated power and the maximum producible ohmic value to the rated voltage!

### Protective measures

All our power resistors with degree of protection IP 20<sup>①</sup> and IP 20<sup>②</sup>, correspond to safety class I, i.e. connections for protective earth conductor according to EN 61140 are provided.



These devices also comply with the CE low voltage directive.

Power resistors being passive electrical or electrical units are not affected by the specific EMC standards. They do not produce any interfering radiations nor are they affected.

### UL-Recognition



Some important type series can be delivered in a version with UL-recognition both for the American and for the Canadian market. The devices are UL 508 approved, number E212934. This recognition is the same as a recognition according to CSA C22.2 No.14. For further information please check the UL-flyer. (Please ask for it or visit us at [www.frizlen.com](http://www.frizlen.com))

### Excess current protection

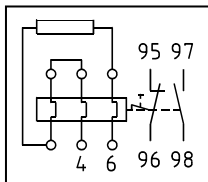

A protection of the resistors against overloading or excess temperature - as demanded in standards - can be realized with the help of a thermal overload relay provided by the user. The set current must correspond to the rated current of the resistor, that is calculated according to continuous duty power and resistance value corresponding to Ohm's law (formula: see "terminal details" p. T108E)

Concerning the series FZ..T the thermal overload relay is a component of the device - with exceeding of the rated current a signal contact is released. There will not be a disconnection of the resistor. Resetting by hand.



## Excess temperature protection

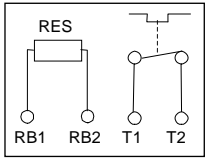

Another kind of the excess temperature monitoring, particularly suited for long-term overloading, is the equipment with a temperature switch. In IP 20-resistor devices it is wired on terminals, in IP 00 resistors the switch is directly connectable and releases a signal contact, when the set temperature is exceeded. There will not be a disconnection of the resistor.

**You can inform yourself about function and restrictions by our data sheet „Tripping of monitoring devices“.**

We can send it to you on request.

## Intrinsically safe version with FRIZLEN DC-POWERSWITCH

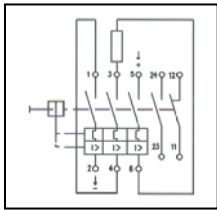

Integrated overload switch for a maximum of 850 VDC to protect the resistor. It protects the integrated resistor against constant overload and against too high short time peak power, e.g. caused by a false operational mode or a fault by an short circuited chopper transistor. Possible damage in the environment by overheating and burning are effectively avoided.

So you receive an intrinsically safe resistor protection degree even for IP20<sup>®</sup>. The FRIZLEN DC-POWERSWITCH can also be integrated in the switch cabinet.

After a successful fault clearance the DC-POWERSWITCH can be switched on like a normal automatic cutout.

We can send you more technical details and characteristics on request.



**Attention: FRIZLEN DC-POWERSWITCH are only suited for monitoring and disconnecting from DC-voltage with pure resistive load (DC1) up to 850 VDC.**

## Contact rating

Contact ratings of the signal contacts of temperature switches and thermal overload relays.

- 2 A / 24 VDC (DC11)
- 2 A / 230 VAC (AC11)

Contact ratings of the signal contacts of the DC-POWERSWITCH:

- 5 A / 24 VDC (DC11)
- 10 A / 230 VAC (AC11)

## Storage temperature/ Operation temperature/ Installation altitude

Storage temperature: - 40° C to 80° C

Operation temperature: - 30° C to 40° C. If the ambient temperature is higher than 40°C, you have to decrease the continuous dissipation by 4% per 10 K temperature rise!

Installation altitude: 2000 m above sea level, you have to decrease the continuous dissipation for 10% per 1000 m altitude, maximum altitude 5000 m above sea level

Restrictions are to be made for the type series FZ.T. and FZ.X. because of the built-in monitoring device. Operation temperature: - 20° C to 40° C

## Typical power/ Continuous dissipation/ Ventilation/ Temperatures

The given typical power values are valid for 100% duty cycle factor (DCF) (continuous dissipation) under the following conditions:

- temperature rise of 200 K at the surface of fixed resistor enclosures (degree of protection > IP00)
- temperature rise of 300 K at the surface of fixed resistor elements (degree of protection IP00)
- unhindered access of cooling air
- unhindered diverting of warmed up air (mind a minimum separation distance of approx. 200 mm to neighbouring components/walls and of approx. 300 mm to components above/ceiling)



### Ventilation/ Temperatures

Since electrical energy is converted into heat, heating up of the exhaust air and of the enclosure at the air outlet is inevitable.

The highest temperature at typical power may be maximum 200°C above the ambient temperature. Since the cooling of the devices is accomplished by convection, the above mentioned aspects have absolutely to be considered.



**In cases of insufficient cooling or false mounting the resistor or the surrounding devices could be overheated or ruined.**

Depending upon use it can be possible to increase the continuous dissipation of the resistors, if higher temperatures are accepted. With an increase of e.g. 130% of the typical power you will have a rise in temperature of 350K at the surface of the resistor. In other cases of application the continuous dissipation must be reduced, for example with temperature sensitive devices in the surrounding area. The dependence between temperature rise and actual continuous dissipation is shown in the diagram below.

*Excess temperature in dependence of continuous dissipation*

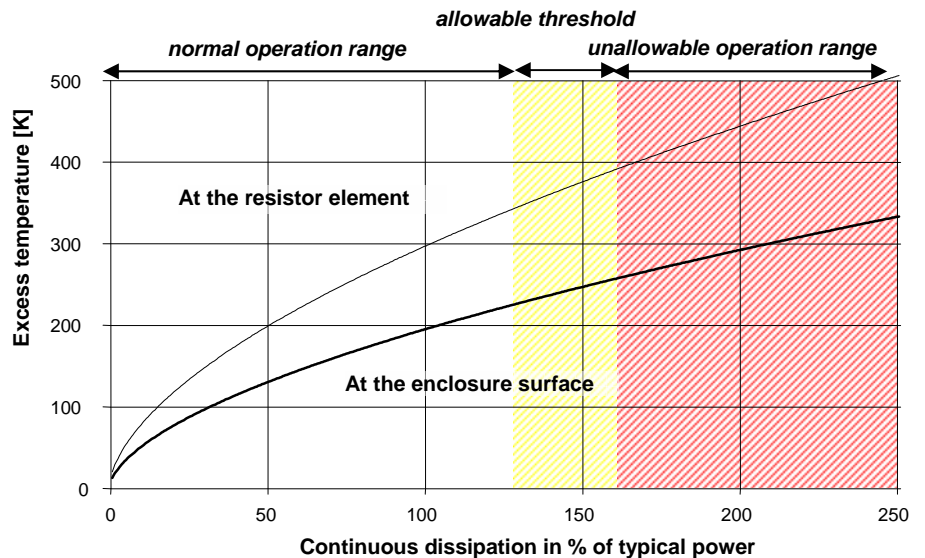

**Normal operation range (up to 130%):**

Recommended operation range for maximum product life and failure free operation

**Allowable threshold (up to 160%):**

Allowable operation range, danger of shorter product life and higher failure probability

**Unallowable operation range (more than 160%):**

Danger of excessive heat and destruction of resistor and neighbouring components



*Short time dissipation/  
Total cycle time/  
Duty cycle factor(DCF)*

At many applications resistors are not loaded in continuous but in short time operation. In the following you will find indications, how to calculate the allowable short time dissipation with the help of the duty cycle factor (DCF) and the overload factor (OLF). If the DCF factor is not known, it can be calculated as follows:

$$Duty\ cycle\ factor(DCF) = \frac{Switch\ on\ time(t_{on})}{Total\ cycle\ time}$$

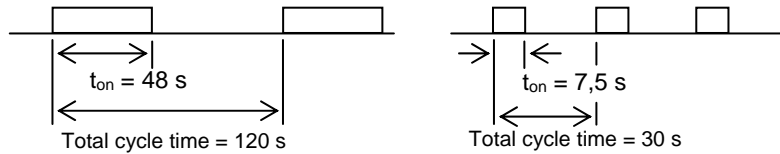

$$DCF_1 = \frac{48s}{120s} = 0,4 = 40\%$$

$$DCF_2 = \frac{7,5s}{30s} = 0,25 = 25\%$$

Warning: The total cycle time may be **maximum 120 s** - shorter total cycle times are possible.  
The total cycle times for motors are mostly higher than 120 s

*Overload factor(OLF)*

By comparison of the known DCF-factor with the following diagram or table you can work out the overload factor (OLF) and/or the continuous and the short time dissipation.

Overload factor (OLF) in dependence of duty cycle factor (DCF)  
(Total cycle time = 120s)

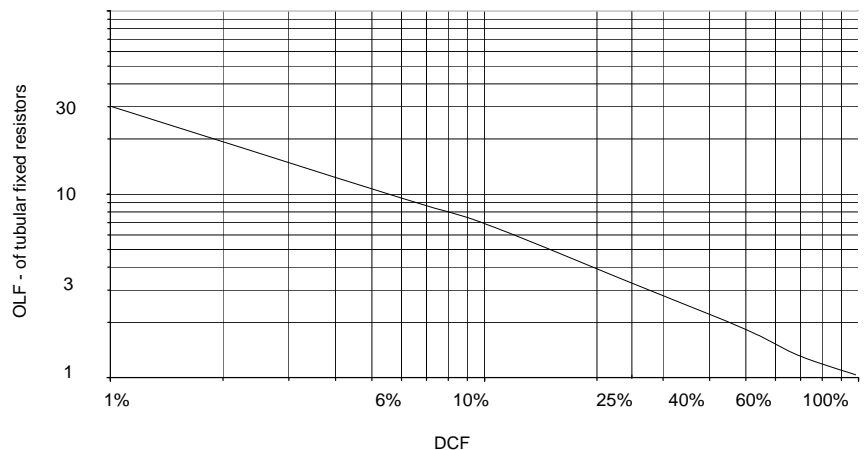

DCF	1%	3 %	6%	15%	25%	40%	60%	80%	100%
OLF	30	15	9,5	5,0	3,2	2,2	1,5	1,12	1,0

The continuous and the short time dissipation can be calculated as follows:

$$Short\ time\ dissipation = Continuous\ dissipation \times OLF$$

$$Continuous\ dissipation = \frac{Short\ time\ dissipation}{Overload\ factor(OLF)}$$

*Calculation example  
given:*

- Resistor with a short time dissipation of 2,5 kW for 18 s and a total cycle time of 120s

*wanted:  
continuous dissipation*

- The duty cycle factor (DCF) is 18 s : 120 s x 100% = 15%
- Overload factor (OLF) for 15% DCF, according to table it is 5,0
- The continuous dissipation is 2,5 kW : 5,0 = 0,5 kW;  
You need a resistor with a continuous dissipation of at least 0,5 kW!





*Terminal details/  
Monitoring devices/  
Cross section*

Rated current and cross section of terminals and monitoring types.

Type	abbreviation	rated current in A with 100% DCF	rated current in A up to 40% DCF	Maximum cross section
porcelain terminal	PK	20	25	up to 2,5 mm <sup>2</sup>
ceramic flat terminal	FK	35	44	2,5 - 10 mm <sup>2</sup>
device terminal out of polyamide (PA)	G 5	30	38	0,5 – 2,5 (4) mm <sup>2</sup> AWG 24 - 12
	G 10	60	75	0,5 – 10 (16) mm <sup>2</sup> AWG 20 - 6
cage clamp terminal out of PA	ST2,5	20	25	up to 2,5 mm <sup>2</sup> AWG 16 - 12
	ST 4	30	38	up to 4,0 mm <sup>2</sup> AWG 20 - 10
thermal overload relay	signal contact	2	-	up to 2,5 mm <sup>2</sup> ; AWG 16-12
	main connection	up to 17/24	21/30	2,5/6 mm <sup>2</sup> ; AWG 20 - 10
DC-POWER-SWITCH FPS	signal contact	10	-	up to 2,5 mm <sup>2</sup> AWG 16 - 12
	main connection	40	50	up to 16 mm <sup>2</sup> ; AWG 4

The rated current is calculated in each case due to Ohm`s law as follows:

$$I = \sqrt{\frac{P}{R}}$$

whereas  
P is the power of the resistor and  
R is the value of the resistance

*Wiring*

If terminals are delivered by us, the connections are wired with flexible, heat resistant, silicone-insulated wire on terminals (further wires on request).  
If the wiring is accomplished by the customer, make sure that a heat resistant wire is used.

*Low-noise and low-inductive version*

By means of a bifilar winding we are able to provide a low-noise and low-inductive version for operations in noise sensible areas, such as braking resistors for frequency converters for lift motors in hospitals or apartment houses. The same is valid for hoist motors on theatre stages.

*Mounting*

Please mind the mounting indications of the corresponding type series!  
You will find these icons in the data sheets.



Allowable: On horizontal surfaces



Allowable: On vertical surfaces, terminals at the bottom



Allowable: Mounting vertical to the mounting sheet, terminals at the bottom



**Not** allowable: On vertical surfaces, terminals at the top, left or right



**Not** allowable: On horizontal surfaces, terminals at the top



Type series FZ / FU  
Type series FZB / FUB

12 – 1000 W for integration  
12 – 300 W with threaded rod

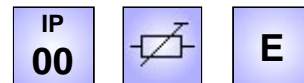

Cemented (FZ) and uncemented (FU) wirewound tubular fixed resistor, degree of protection IP00.  
Type series F.B. additionally with mounted threaded rod, fixing vertically to mounting surface.

Variable connections at the soldering, fast-on or screw clips\* on the resistor.

\*Particular specifications for „low ohmic values“ – for details please look on the following page

## Technologies

- connection directly at the resistor
- optional, depending on construction size with screw, fast-on or soldering connection
- adjustable clips (Ags.) available (please mind the hints on this page and on the following one)
- with type series F.B.. only small mounting space is needed
- mounting in switch cabinets

We provide M3 screw connections for construction sizes with diameters D=16 and M4 with D=24/35/45 M5 with D=65. Also fast-on connections (6,3x0,8) are available for sizes with D=24/35/45.

For sizes with D=16 the soldering connections can also be used as fast-on connections (4,8x0,5).

You will find the electrical and mechanical data on the next page.

You will find indications for the relationship between load capacity and temperature on the surface as well as for the dimensioning of the resistor at short term load in chapter “Technical Details”, pages T103E-T108E.

## Application

As ballast, limiting, filter or series resistors etc. for integration into devices and customised units. Our type series F.B.. is very well applicable in switch cabinets. We fix the threaded rod for you in a space-saving way. Efficient use in your manufacturing systems.

## Special design

- various tube sizes as well as lower and higher ohmic values on request
- beginning with size D=24 also with temperature switch (TS) with fast-on connections 6,3 x 0,8
- soldering connections, pretinned

## Type designation (standard)

### Types with soldering connections (4,8x0,5)

size	without adjustable clips (Ags.)	with 1 Ags.	with n Ags.
D=16	FZ..x16A	FZ..x16AE	FZ..x16AnE

### Types with fast-on connections (6,3x0,8, also solderable)

size	without adjustable clips (Ags.)	with 1 Ags.	with n Ags.
D=24	FZ..x24S	FZ..x24ST	FZ..x24SnT
D=35	FZ..x35S	FZ..x35ST	FZ..x35SnT
D=45	FZ..x45S	FZ..x45ST	FZ..x45SnT

### Types with screw connections (M3 / M4 / M5)

size	without adjustable clips (Ags.)	with 1 Ags.	with n Ags.
D=16	FZ..x16	FZ..x16F	FZ..x16Fn
up to	....	....	....
D=65	FZ..x65	FZ..x65F	FZ..x65Fn

## Hints for the versions with adjustable clips

For the cemented fixed resistors with adjustable clip we decrease the available maximum ohmic value. Since otherwise while adjusting the clip, the danger of breaking the wire would be too large because of too thin wires. The adjustable clip may only be adjusted in a condition free of voltage and after sufficient loosening and cooling. All the adjustable clips of our fixed resistors in tubular version are equipped with silver contacts. When selecting please consider that the maximum surface temperature (ST) should not exceed 300°C.

Please consider as well that the resistance value may be reduced with versions where several adjustable clips are combined, especially in the lower range of ohmic values and with short tube lengths. In that case we have to select a higher total ohmic value.

## Example of dimensioning and selection of a specific unit:

Adjustable power resistor for mounting into a switch cabinet with 2 additional taps: continuous dissipation 150 W; resistance value 100 Ω; rating 110 V DC, mounting by threaded rod on mounting plate, adjustable resistance taps by 2 adjustable clips, connection at fast-on clips,

Selected: FZB 200 x 35 S2T – 100 with continuous dissipation 150 W  
Alternatively: FZB 160 x 45 S2T – 100 (continuous dissipation also 150W)

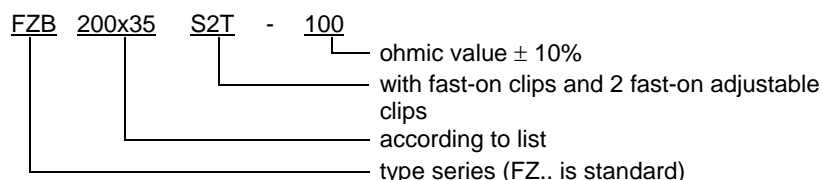



Type series FZ / FU  
Type series FZB / FUB

12 - 1000 W for integration  
12 – 300 W with threaded rod

### Electrical and mechanical data

type series FZ.. (standard) /FU.. L x D	typical power in W at 40°C, 100% DCF and 300°C ST	production range Ω-Wert					dimension in mm						approx. weight in g
		for screw clips	for soldering and fast-on clips from	with adjustable clip	without adjustable clip	with adjustable clip(s) up to	B	E	only for types with screw clips F*		G	only type series FZB./ FUB. T	
F. 50x16..	12	0,27	0,27	0,68	6,8k	1,8k	20	34	33		33	72	40
F. 63x16..	18	0,39	0,39	1,0	10k	2,7k	20	45	33	M3	33	87	50
F. 100x16..	34	0,68	0,68	1,8	18k	4,7k	20	82	33		33	122	60
F. 75x24..	32	0,1	0,33	1,8	18k	3,9k	28	55	34		44	97	100
F. 100x24..	44	0,15	0,47	2,2	27k	5,6k	28	78	34	M4	44	122	120
F. 165x24..	80	0,33	1,0	3,9	39k	10k	28	137	34		44	190	190
F. 265x24..	140	0,56	1,8	8,2	68k	15k	28	237	34		44	290	300
F. 100x35..	65	0,22	0,68	1,0	22k	8,2k	38	78	44		53	122	160
F. 135x35..	100	0,33	1,0	2,2	33k	12k	38	113	44	M4	53	155	210
F. 200x35..	150	0,56	1,8	8,2	47k	15k	38	172	44		53	220	290
F. 330x35..	250	1,0	2,7	12	82k	27k	38	282	44		53	350	460
F. 160x45..	150	0,47	6,8	6,8	33k	10k	48	125	54		63	178	340
F. 200x45..	180	0,68	10	10	39k	12k	48	164	54	M4/ M5**	63	220	450
F. 300x45..	300	1,2	15	15	56k	18k	48	250	54		63	320	560
F. 300x65..	430	6,8		20	47k	18k	68	250	80		90		1100
F. 400x65..	600	10	special design	30	68k	22k	68	350	80		90	special design	1400
F. 500x65..	800	12		39	82k	33k	68	450	80	M5	90		1800
F. 600x65..	1000	15		47	100k	39k	68	550	80		90		2100

\*when equipped with an additional adjustable clip, maximum dimension for the version with screw connection is dimension G instead of dimension F! (Comparable to types with fast-on connection) \*\* for smaller resistor values M5, more details on request

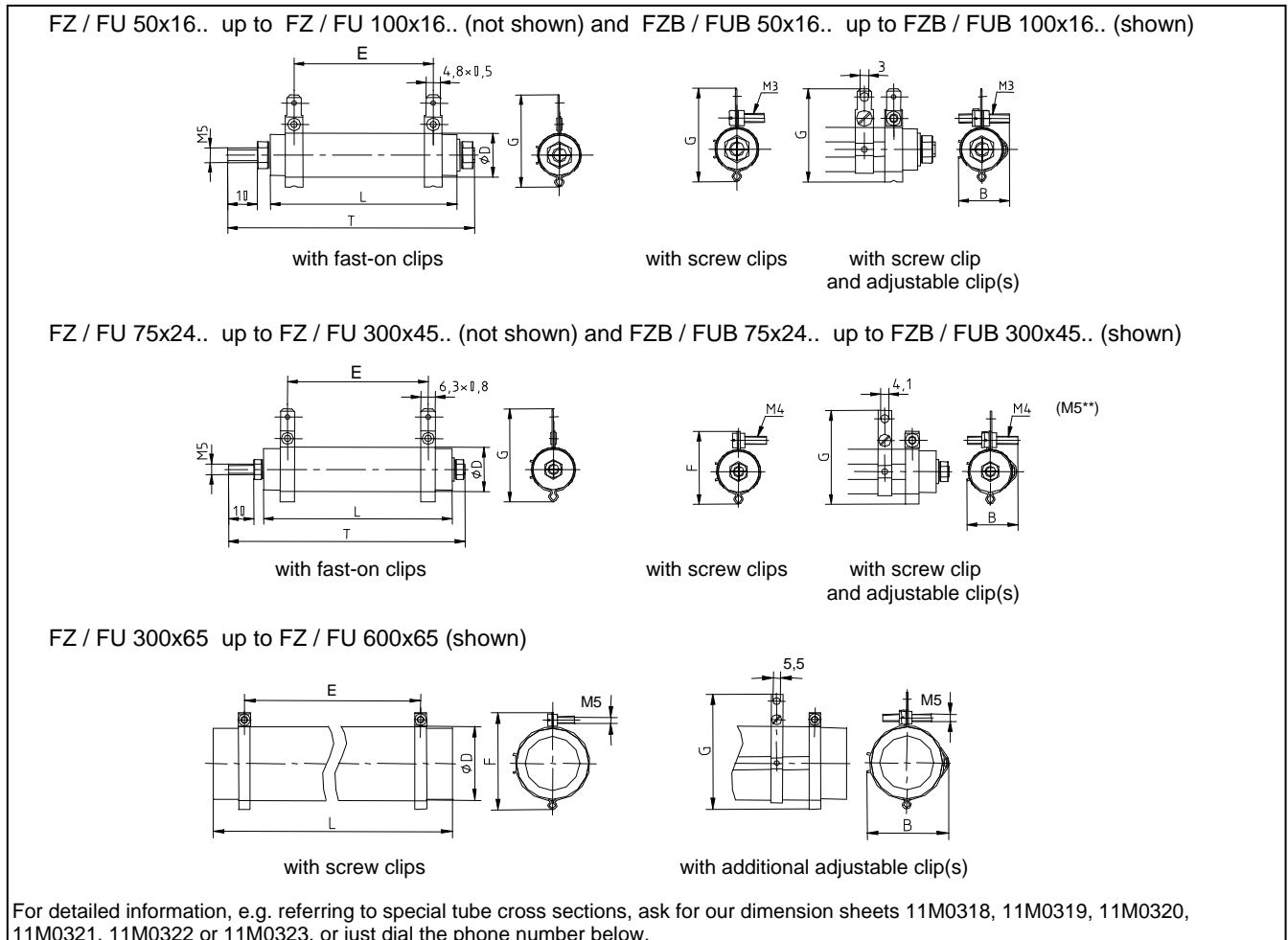



Type series FZ...L / FU...L

12 – 44 W with soldering clips,  
for mounting on a printed circuit board

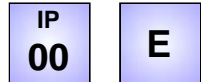

Cemented wirewound tubular fixed resistor, degree of protection IP00, for soldering on printed circuit boards, mounting and connection by soldering clips horizontal to mounting surface. Connections pretinned.

**Technologies**

- connection and mounting directly by means of the resistor soldering clips
- mounting directly on PCB

The given power values can be essentially increased during short time operation as a function of the duty cycle factor (DCF) The peak power can be easily calculated. Just multiply the values by the corresponding overload factors (OLF) of this table:

DCF	60%	40%	25%	15%	6%
OLF	1,5	2,2	3,2	5,0	9,5

These overload factors OLF are valid for a total cycle time of maximum 120 s

You will find further indications in chapter "Technical Details", pages T103E-T108E.

**Application**

As ballast, limiting, filter or series resistors on printed circuit boards.

Reliable and efficient manufacturing process by optionally pretinned soldering connections.

**Special design**

- Special sizes on request

**Electrical and mechanical data**

Type series	typical power in W at 40°C, 100% DCF and 300°C ST	production range Ω-value		dimensions in mm		approx. weighting
		from	up to	L	E	
FZ..L (standard) /FU..L	L x D					
F. 50x16L	12	0,27	6,8k	50	34	45
F. 63x16L	18	0,39	10k	63	45	55
F. 100x16L	34	0,68	18k	100	82	65
F. 75x24L	32	0,33	18k	75	55	120
F. 100x24L	44	0,47	27k	100	78	320

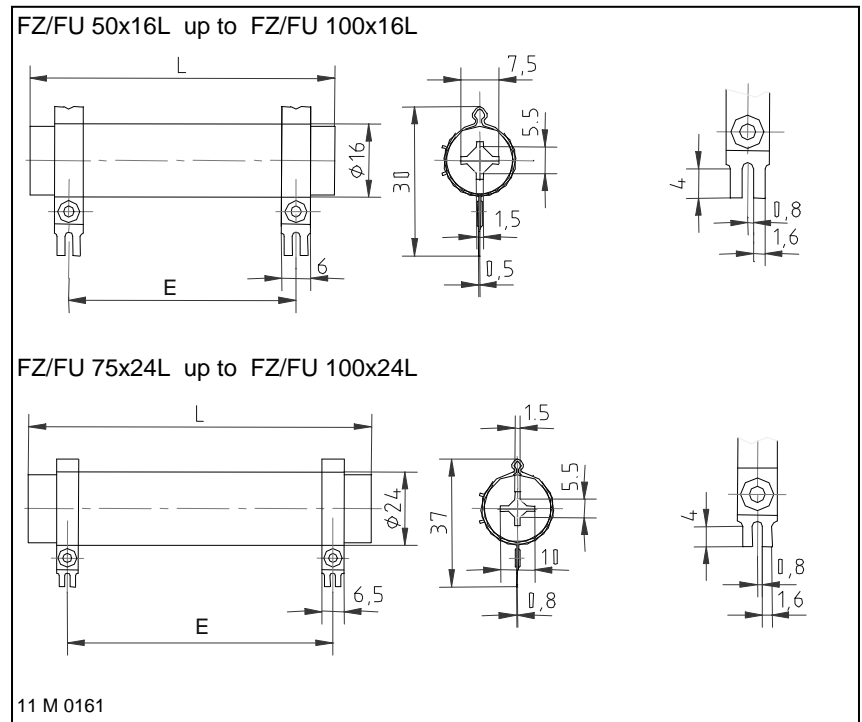

**Example of dimensioning and selection of a specific unit:**

resistor for mounting on a printed circuit board : continuous dissipation 30 W;  
resistance value 1 kΩ;  
selected: FZ 75x24 L – 1k with continuous dissipation 32 W

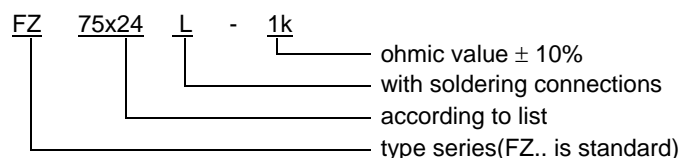





Type series FZS / FUS

12 – 250 W with fastening brackets

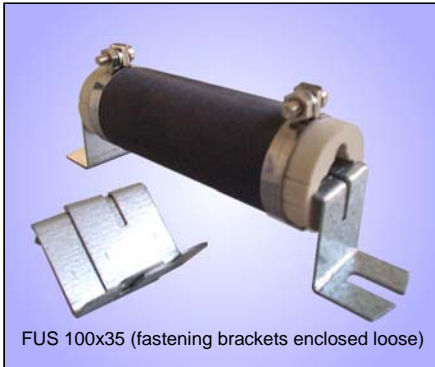

FUS 100x35 (fastening brackets enclosed loose)

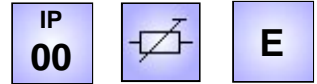

Cemented wirewound tubular fixed resistor, degree of protection IP00, with insertable fastening brackets which are enclosed loose, fixing parallel to mounting surface. Connections by screw, fast-on or soldering clips of the resistor\*.

\*For available connection types and designations please see pages T109E/110E

### Technologies

- connections directly at the resistor
- optional with either screw, fast-on or soldering connections
- integration into switch cabinets
- adjustable clips available
- insertable fastening brackets are enclosed loose.

The given power values are valid for 100%DCF (continuous dissipation) at an ambient temperature of max. 40°C and a surface temperature (ST) of 300°C. The values can be increased by the factor 1,3. Then the ST will increase up to approx. 350°C.

The given power values can be essentially increased during short time operation as a function of the duty cycle factor (DCF) The peak power can be easily calculated. Just multiply the values by the corresponding overload factors (OLF) of this table:

DCF	60%	40%	25%	15%	6%
OLF	1,5	2,2	3,2	5,0	9,5

These overload factors are valid for a total cycle time of maximum 120 s.

### Application

As ballast, limiting, filter or series resistors etc in switch cabinets or electric devices.

Low price and efficient operation by the easy and quick application of insertable fastening brackets in manufacturing.

### Special design

- from construction size D=24 on with temperature switch (TS) with fast-on connections 6,3 x 0,8

### Electrical and mechanical data

Type series	typical power in W at 40°C, 100% DCF and 300°C ST	production range Ω-Wert		dimensions in mm								approx. weight in g	
		from	up to	B	E	H	J	M	O	R	∅P		
FZS.. (standard)													
FUS..													
L x D													
F.S 50x16	12	0,27	6,8k	18	34	42	42	70	83	10	3,0	35	
F.S 63x16	18	0,39	10k	18	45	42	42	84	97	10	3,0	40	
F.S 100x16	34	0,68	18k	18	82	42	42	120	133	10	3,0	50	
F.S 75x24	32	0,1	18k	25	55	47	56	95	108	16	4,1	85	
F.S 100x24	44	0,15	27k	25	78	47	56	120	133	16	4,1	110	
F.S 165x24	80	0,33	39k	25	137	47	56	185	198	16	4,1	170	
F.S 265x24	140	0,56	68k	25	237	47	56	285	298	16	4,1	260	
F.S 100x35	65	0,22	22k	38	78	54	63	125	146	25	4,1	160	
F.S 135x35	100	0,33	33k	38	113	54	63	160	181	25	4,1	200	
F.S 200x35	150	0,56	47k	38	172	54	63	225	246	25	4,1	280	
F.S 330x35	250	1,0	82k	38	282	54	63	355	376	25	4,1	440	

For further details concerning the ohmic values please see pages T109E/110E.

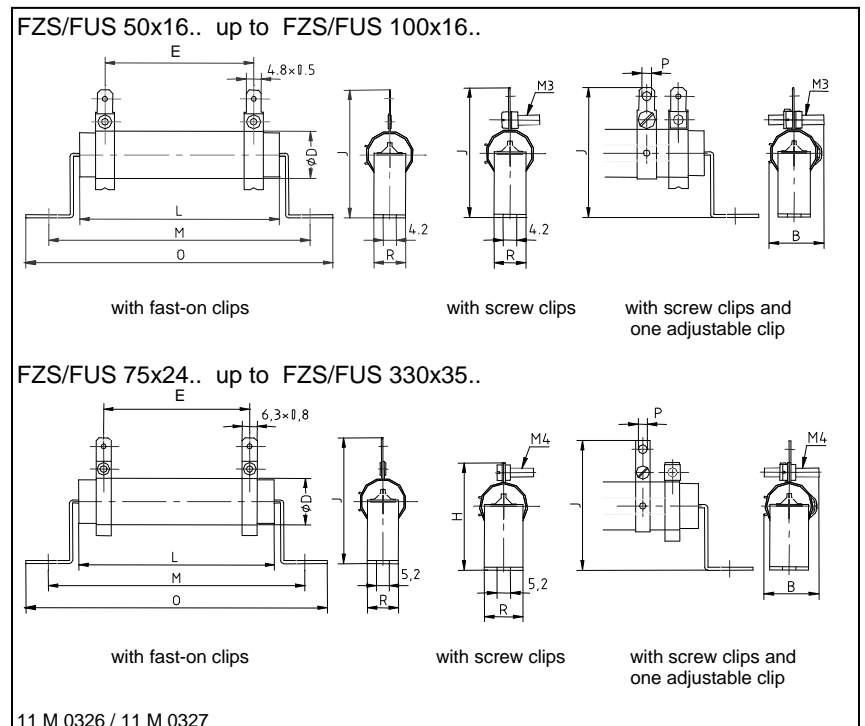

Example: Continuous dissipation 140 W, resistance value 390 Ω with 1 adjustable clip, with screw connections

Ordering designation: FZS 265x24 F – 390



Type series FZW / FUW

12 – 300 W with screwed fastening brackets

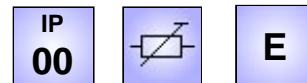

Cemented wirewound tubular fixed resistor, degree of protection IP00, with screwed fastening brackets, fixing parallel to mounting surface. Connections at screw, fast-on or soldering clips of the resistor\*.

\*For available connection types and designations please see pages T109E/110E

**Technologies**

- connections directly at the resistor
- optional with either screw, fast-on or soldering connection
- integration into switch cabinets
- adjustable clips available
- with screwed fastening brackets

The given power values are valid for 100%DCF (continuous dissipation) at an ambient temperature of max. 40°C and a surface temperature (ST) of 300°C. The values can be increased by the factor 1,3. Then the ST will increase up to approx. 350°C.

The given power values can be essentially increased during short time operation as a function of the duty cycle factor (DCF) The peak power can be easily calculated. Just multiply the values by the corresponding overload factors (OLF) of this table:

DCF	60%	40%	25%	15%	6%
OLF	1,5	2,2	3,2	5,0	9,5

These overload factors are valid for a total cycle time of maximum 120 s.

**Application**

As ballast, limiting, filter or series resistors etc in switch cabinets or electric devices.

Efficient operation by the prefixed screwed fastening brackets in a range of industries.

**Special design**

- from construction size D=24 on with temperature switch (TS) with fast-on connections 6,3 x 0,8

**How to order: Example:**

Continuous dissipation 250 W, resistance value 5,6 Ω  
 Is to be wired at fast-on connections (without adjustable clip)  
 Type designation then:  
 FZW 330x35 S – 5,6

**Electrical and mechanical data**

Type series FZW.. (standard) FUW..	typical power in W at 40°C, 100% DCF and 300°C ST	production range Ω-Wert		dimensions in mm								approx. weight	
		from	up to	B	E	H	J	M	O	ØP	R		
L x D													
F.W 50x16	12	0,27	6,8k	18	34	42	42	70	83	3,0	10	45	
F.W 63x16	18	0,39	10k	18	45	42	42	84	97	3,0	10	55	
F.W 100x16	34	0,68	18k	18	82	42	42	120	133	3,0	10	65	
F.W 75x24	32	0,1	18k	28	55	47	56	95	115	4,1	20	120	
F.W 100x24	44	0,15	27k	28	78	47	56	120	140	4,1	20	150	
F.W 165x24	80	0,33	39k	28	137	47	56	185	205	4,1	20	210	
F.W 265x24	140	0,56	68k	28	237	47	56	285	305	4,1	20	320	
F.W 100x35	65	0,22	22k	38	78	52	63	120	140	4,1	20	180	
F.W 135x35	100	0,33	33k	38	113	52	63	155	175	4,1	20	220	
F.W 200x35	150	0,56	47k	38	172	52	63	220	240	4,1	20	310	
F.W 330x35	250	1,0	82k	38	282	52	63	350	370	4,1	20	480	
F.W 160x45	150	0,47	33k	48	125	69	78	184	200	4,1	40	380	
F.W 200x45	180	0,68	39k	48	164	69	78	224	240	4,1	40	430	
F.W 300x45	300	1,2	56k	48	250	69	78	324	340	4,1	40	600	

For further details concerning the ohmic values please see pages T109E/110E.

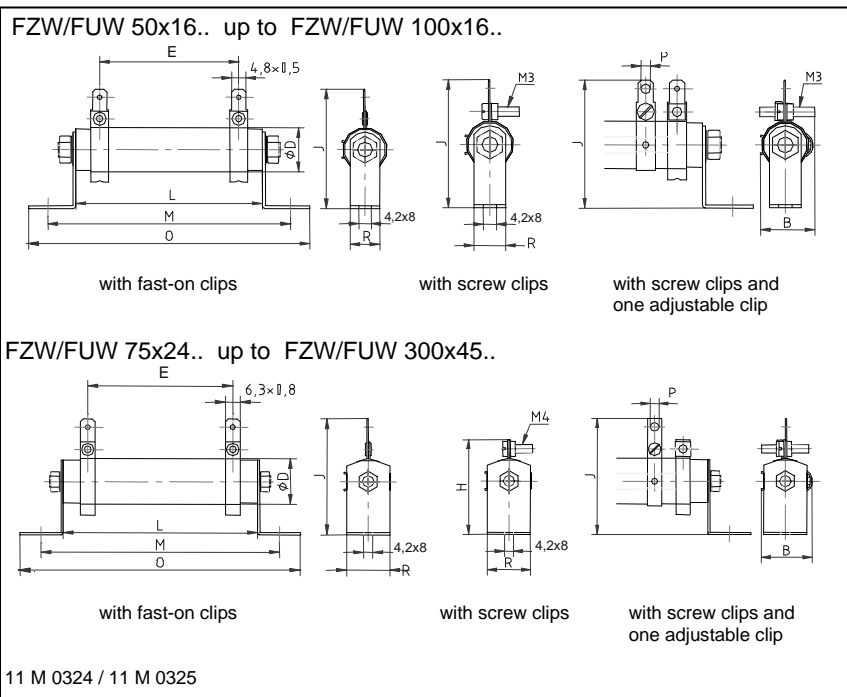



Type series FZP / FZN / FZR  
and FUP / FUN / FUR

12 – 300 W for vertical mounting



Cemented wirewound tubular fixed resistor in one-tube design, degree of protection IP20<sup>②</sup>, in perforated steel sheet enclosure, mounting vertical to mounting surface, connections optionally at terminals or at screw or fast-on clips at the resistor. For integration into switch cabinets.

② terminals protected against access to hazardous parts according to BGV A2

③ optional for D = 45, type designation would be FZP.U ..., width 87,5 mm instead of 65 mm (construction with device terminals G10/G5)

### Technologies

- protected against access to hazardous parts
- only small fixing space needed
- mounting vertically on mounting plate
- connections at terminals or at screw or fast-on clips
- adjustable clips (Ags.) available with type series FZR, FUR, FZN, FUN

### Option: temperature switch (..Q)

Available for type series FZP beginning with size D = 24 mm, for D=45 only in larger enclosure with width of 87,5 mm instead of 65 mm.

This type can be equipped with a 180° C temperature switch for monitoring. The switch is wired on porcelain terminals and signals an overloading of the resistor. This is done by a normally closed contact free of potential (NCC). This signal has to be considered by the customer, e.g. by warning or disconnection of the mains. (Restrictions please look on page T105E).

**Warning:** There will not be a disconnection of the resistor!  
Type designation then: FZPQ ...

Contact rating of the signal contact:

- 2 A / 24 VDC (DC11)
- 2 A / 230 VAC (AC11)

You will find suggestions for the dimensioning of the resistor for continuous and short term load at chapter Technical Details, pages T106E and T107E.

### Application

This type is used as a ballast, limiting, filter or series resistor and is perfectly suited for integration into switch cabinets.

### Special design

- we provide polyamide device terminals G5

### Description of the different types

#### Type F.P (Standard)

2 connections wired on a porcelain terminal, which is accessible without demounting the cover and protected against access to hazardous parts according to BGV A2. The terminal is fixed on the enclosure front plate. Adjustable clip not available. Temperature switch available.

#### Type F.N

2 connections wired on a porcelain terminal, which is accessible without demounting the cover and protected against access to hazardous parts according to BGV A2. The terminal is fixed on the enclosure bottom plate. Adjustable clips available. Temperature switch not available.

#### Type F.R

2 connections directly at the resistor, which are accessible after unscrewing the enclosure front plate. Adjustable clips available. Temperature switch not available.

### Electrical and mechanical data

Type series	typical power in W at 40°C, 100% DCF	production range Ω-value		dimensions in mm		approx. weight in g
		from	up to	D*	H*	
FZP (standard) / F.N / F.R						
L x D (**)						
F.P 50x16 (A)	12	0,27	6,8k	100	141	330
F.P 63x16 (A)	18	0,39	10k	100	141	340
F.P 100x16 (A)	34	0,68	18k	100	141	350
F.P 75x24 (S)	32	0,1	18k	100	141	370
F.P 100x24 (S)	44	0,15	22k	100	141	400
F.P 165x24 (S)	80	0,33	12k	100	238	500
F.P 100x35 (S)	65	0,22	18k	100	141	500
F.P 135x35 (S)	100	0,33	10k	100	238	600
F.P 200x35 (S)	150	0,56	6,8k	100	238	700
F.P 160x45 (S)	150	0,47	6,8k	100	238	700
F.P 200x45 (S)	180	0,68	5,6k	100	238	800
F.P 300x45 (S)	300	1,2	3,9k	100	336	1100

(\*\*)Type series F.P/F.N are generally equipped with fast-on clips. Type designation would be ..A or ..S, except for low ohmic values. As far as type series F.R is concerned, you are free to choose. For further details please see pages T109E/110E.

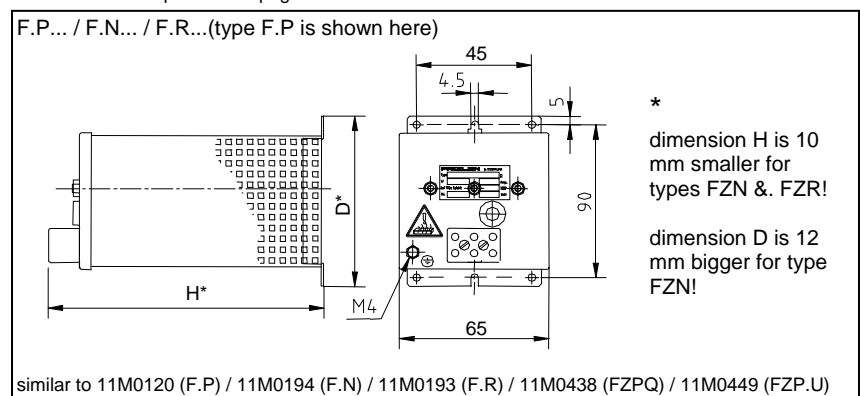



Type series FZZP / FZDP  
and FUZP / FUDP

24 – 900 W for vertical mounting

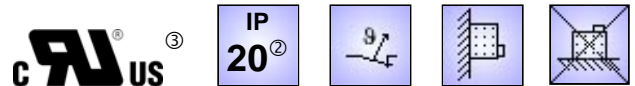

Cemented wirewound tubular fixed resistor in two-tubes (F.ZP) or three-tubes design (F.DP), degree of protection IP20<sup>②</sup>, in perforated steel sheet enclosure, mounting vertical to mounting surface. For integration into switch cabinets. Standard version:

One-phase resistor with 2 connections at terminals on the enclosure front plate.

② terminals protected against access to hazardous parts according to BGV A2

③ optional for D = 45, type designation would be FZ.P.U..  
(version with device terminals G10/G5)

**Technologies**

- protected against access to hazardous parts
- only small fixing space needed
- vertical mounting on mounting plate
- two - or three-phase version, also available with star point in the unit, i.e. connections at 2, 3, 4 or 6 terminals

**Option: temperature switch (..Q)**

- beginning with size D = 24 mm only!

This type can be equipped with a 180° C temperature switch for temperature monitoring. It is wired on porcelain terminals and monitors an overloading of the resistor by a normally closed contact free of potential (NCC). This signal has to be considered by the customer e.g. by a warning or disconnection of the mains. (Restrictions please look on page T105E).

**Warning:** There will not be a disconnection of the resistor!  
Type designation then: FZ.PQ ...

Contact rating of the signal contact:

- 2 A / 24 VDC (DC11)
- 2 A / 230 VAC (AC11)

You will find suggestions for the dimensioning of the resistor for continuous and short term load at chapter Technical Details, pages T106E and T107E.

**Application**

This type is used for limiting the switch-on current and for short – circuit braking in a three-phase version. Also as filter, braking or series resistor in a one- or two-phase version. It is perfectly suited for integration into switch cabinets.

**Special design**

- with polyamide device terminals G5 (max. 6 term. without TS or 3 term. with TS)

**Electrical and mechanical data**

Type series F.Z.P (standard) /F..N/F..R L x D (*)	typical power in W at 40°C, 100% DCF	production range Ω-value		dimensions in mm				approx. weight in kg
		from	up to	A	B	C	H	
F.ZP 50x16 (A)	24	0,47	12k	22,5	87,5	67,5	123	0,42
F.ZP 63x16 (A)	36	0,68	18k	22,5	87,5	67,5	123	0,43
F.ZP 100x16 (A)	68	1,2	15k	22,5	87,5	67,5	123	0,45
F.ZP. 75x24 (S)	64	0,18	18k	45	110	90	123	0,62
F.ZP. 100x24 (S)	88	0,27	8,2k	45	110	90	123	0,70
F.ZP. 165x24 (S)	160	0,56	6,8k	45	110	90	190	0,85
F.ZP. 100x35 (S)	130	0,39	8,2k	75	140	120	220	1,20
F.ZP. 135x35 (S)	200	0,56	5,6k	75	140	120	220	1,30
F.ZP. 200x35 (S)	300	1,0	3,9k	75	140	120	220	1,40
F.ZP. 160x45 (S)	300	0,82	3,9k	105	178	150	220	1,40
F.ZP. 200x45 (S)	360	1,2	2,7k	105	178	150	220	1,50
F.ZP. 300x45 (S)	600	2,2	1,8k	105	178	150	318	2,00
F.DP 50x16 (A)	36	0,82	27k	22,5	87,5	67,5	123	0,45
F.DP 63x16 (A)	54	1,0	18k	22,5	87,5	67,5	123	0,47
F.DP 100x16 (A)	102	1,8	10k	22,5	87,5	67,5	123	0,50
F.DP. 75x24 (S)	96	0,27	12k	45	110	90	123	0,70
F.DP. 100x24 (S)	132	0,47	8,2k	45	110	90	123	0,80
F.DP. 165x24 (S)	240	1,0	4,7k	45	110	90	190	1,10
F.DP. 100x35 (S)	195	0,68	5,6k	75	140	120	220	1,30
F.DP. 135x35 (S)	300	1,0	3,9k	75	140	120	220	1,40
F.DP. 200x35 (S)	450	1,5	2,7k	75	140	120	220	1,60
F.DP. 160x45 (S)	450	1,2	2,7k	105	178	150	220	1,60
F.DP. 200x45 (S)	540	1,8	1,8k	105	178	150	220	1,90
F.DP. 300x45 (S)	900	3,3	1,2k	105	178	150	318	2,50

(\*)The versions above are generally equipped with fast-on clips. Type designation would be ..A or ..S. except for: low ohmic values. For further details please see pages T109E/110E.

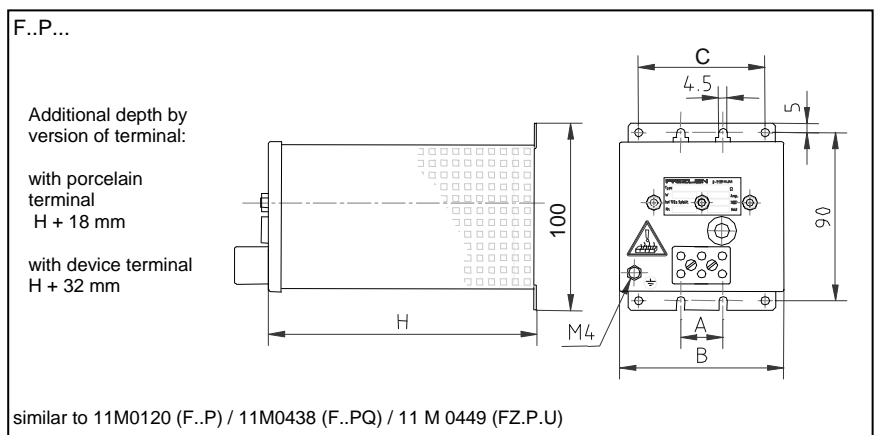

Example: Continuous dissipation 3x150W, resistance value 3x120Ω, star point in the device (connection at 3 porcelain terminals)  
Ordering designation: FZDP 200x35S – 3x120





Type series FZH / FZZH / FZDH

430 – 3000 W with side-panels

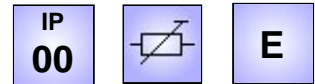

Cemented wirewound tubular fixed resistor, degree of protection IP00 with side-panels, fixing parallel to mounting surface. Connections at screw or fast-on clips at the resistor.

### Technologies

- connection directly at the resistor
- integration into switch cabinets
- adjustable clips possible

The given power values are valid for 100%DCF (continuous dissipation) at an ambient temperature of max. 40°C and a surface temperature (ST) of 300°C. The values can be increased by the factor 1,3. Then the ST will increase up to approx. 350°C.

The given power values can be essentially increased during short time operation as a function of the duty cycle factor (DCF) The peak power can be easily calculated. Just multiply the values by the corresponding overload factors (OLF) of this table:

DCF	60%	40%	25%	15%	6%
OLF	1,5	2,2	3,2	5,0	9,5

These overload factors are valid for a total cycle time of maximum 120 s.

### Application

Various applications derive from the compact construction form. Is to be integrated into a switch cabinet.

This low price alternative is suitable for educational modelling applications e.g. with protected extra-low voltage.

### Special design

- with temperature switch (TS), type designation then FZ.HQ, connection of the TS at fast-on connections 6,3 x 0,8

### Electrical and mechanical data

Type series	typical power in W at 40°C, 100% DCF as well as 300°C ST	production range Ω-value		dimensions in mm					approx. weight in kg
		from	up to	H	M	O	R	U	
FZH 300x65	430	6,8	47k	120	320	340	92	64	1,5
FZH 400x65	600	10	68k	120	420	440	92	64	1,9
FZH 500x65	800	12	82k	120	520	540	92	64	2,2
FZH 600x65	1000	15	100k	120	620	640	92	64	2,6
FZZH 300x65	860	3,9	82k	120	320	340	185	150	3,0
FZZH 400x65	1200	5,6	120k	120	420	440	185	150	3,8
FZZH 500x65	1600	6,8	150k	120	520	540	185	150	4,4
FZZH 600x65	2000	8,2	180k	120	620	640	185	150	5,2
FZDH 300x65	1300	2,7	82k	120	320	340	275	240	4,5
FZDH 400x65	1800	3,3	120k	120	420	440	275	240	5,7
FZDH 500x65	2400	3,9	150k	120	520	540	275	240	6,6
FZDH 600x65	3000	5,6	180k	120	620	640	275	240	7,8

For further details concerning the range of ohmic values with adjustable clips please see pages T109E/110E.

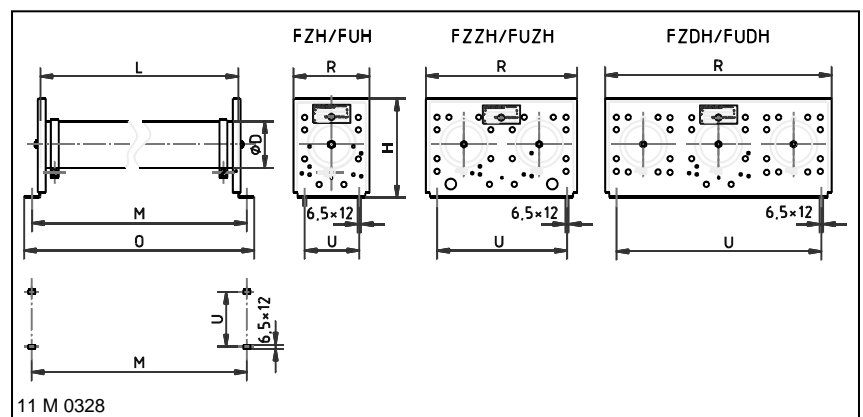

### Example of dimensioning and selection of a specific unit:

one-phase load resistor for experimental setup:  
 Continuous dissipation approx.. 350 W at 7,5 Ω; resistance value adjustable between about 5 - 15 Ω; rating voltage 50 V DC, resistance value variable by additional adjustable clip, connection at screw connections,  
 selected: FZH 500 x 65 F – 15 with continuous dissipation 800 W (400 W at R/2)

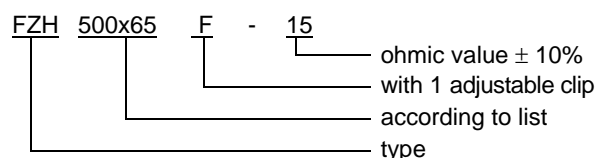



Type series FZA / FZZA / FZDA

65 – 3000 W with cover

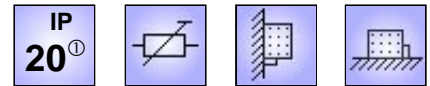

Cemented wirewound tubular fixed resistor in one-, two- or three-tubes design, degree of protection IP20 if mounted on an appropriate surface, with side-panels and perforated cover. Fixing parallel to mounting surface. Connections at screw clips at the resistor tube.

① if mounted on an appropriate surface

**Technologies**

- low price version protected against access to hazardous parts
- connections at screw clips at the resistor
- wall mounting or mounting on switch cabinets
- adjustable clips available

The given power values are valid for 100%DCF (continuous dissipation) at an ambient temperature of max. 40°C and a surface temperature (ST) of 300°C. The values can be increased by the factor 1,3. Then the ST will increase up to approx. 350°C.

The given power values can be essentially increased during short time operation as a function of the duty cycle factor (DCF) The peak power can be easily calculated. Just multiply the values by the corresponding overload factors (OLF) of this table:

DCF	60%	40%	25%	15%	6%
OLF	1,5	2,2	3,2	5,0	9,5

These overload factors are valid for a total cycle time of maximum 120 s

**Application**

An important application is the use as damping resistor in switch plants.

Various applications derive from the compact construction form for wall mounting and mounting on or in a switch cabinet or switch plant.

**Special design**

- with temperature switch (TS) – type designation then FZ.AQ, connection of the TS at fast-on connections 6,3 x 0,8
- with fast-on clips 6,3 x 0,8

**Electrical and mechanical data**

Type series	typical power in W at 40°C, 100% DCF	production range Ω-value		dimensions in mm						approx. weight in kg
		from	up to	H	K	M	O	R	U	
FZA 100x35	65	0,22	18k	77	4,5	122	137	66	44	0,5
FZA 135x35	100	0,33	10k	77	4,5	157	172	66	44	0,6
FZA 200x35	150	0,56	6,8k	77	4,5	222	237	66	44	0,7
FZA 330x35	250	1,0	4,7k	77	4,5	352	367	66	44	1,1
FZA 160x45	150	0,47	6,8k	87	5,8	186	206	75	48	0,7
FZA 200x45	180	0,68	5,6k	87	5,8	226	246	75	48	0,8
FZA 300x45	300	1,2	3,9k	87	5,8	326	346	75	48	1,1
FZA 300x65	430	6,8	2,7k	120	6,5	330	346	92	64	1,7
FZA 400x65	600	10	1,8k	120	6,5	430	446	92	64	2,2
FZA 500x65	800	12	1,5k	120	6,5	530	546	92	64	2,7
FZA 600x65	1000	15	1,0k	120	6,5	630	646	92	64	3,3
FZZA 300x65	860	3,9	1,2k	120	6,5	326	346	185	150	3,4
FZZA 400x65	1200	5,6	1,0k	120	6,5	426	446	185	150	4,2
FZZA 500x65	1600	6,8	680	120	6,5	526	546	185	150	5,1
FZZA 600x65	2000	8,2	560	120	6,5	626	646	185	150	6,1
FZDA 300x65	1300	2,7	820	120	6,5	326	346	275	240	5,4
FZDA 400x65	1800	3,3	560	120	6,5	426	446	275	240	6,4
FZDA 500x65	2400	3,9	470	120	6,5	526	546	275	240	7,4
FZDA 600x65	3000	5,6	390	120	6,5	626	646	275	240	8,7

For further details concerning the range of ohmic values with adjustable clips please see pages T109E/110E

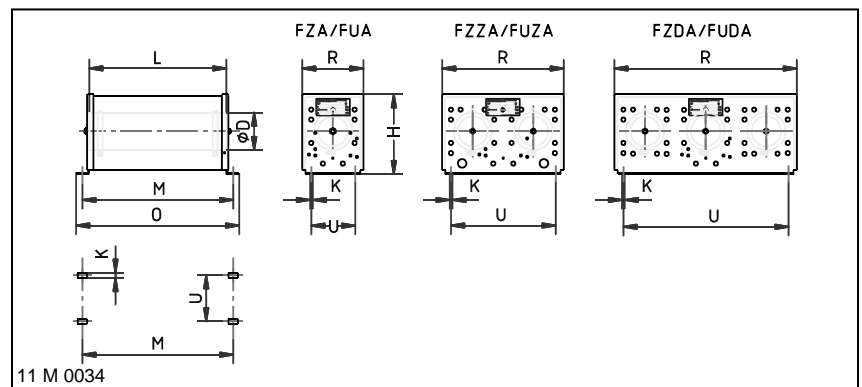

Example:

Continuous dissipation 600 W, resistance value 25 Ω, with adjustable clips

Ordering designation:

FZA 400x65 F – 25



Type series FZM / FZZM / FZDM

65 – 3000 W with terminals



FZM 400x65

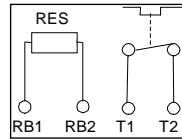

Cemented wirewound tubular fixed resistor in one-, two- or three-tube design, degree of protection IP20 if mounted on an appropriate surface, with side-panels and perforated cover. Fixing parallel to mounting surface, with two connections wired on porcelain terminals

- ① if mounted on an appropriate surface
- ② terminals protected against access to hazardous parts according to BGV A2
- ③ optional for D = 45 and 65, type designation then FZ.M.U or FZ.M.QU.. (version with device terminals G10/G5)

### Technologies

- with side-panels, perforated cover and terminals
- version protected against access to hazardous parts
- connections at two-pole porcelain terminal up to 20A
- integration into the switch cabinets

**Option: temperature switch (..Q)**  
- beginning with size D = 45 mm only!

This type can be equipped with a 180° C temperature switch (TS) for temperature monitoring. It is wired on porcelain terminals and monitors an overloading of the resistor by a normally closed contact free of potential (NCC). This signal has to be considered by the customer e.g. by a warning or disconnection of the mains. (Restrictions please look on page T105E)

**Warning:** There will not be a disconnection of the resistor!  
Type designation then: FZ.MQ ...

Contact rating of the signal contact:

- 2 A / 24 VDC (DC11)
- 2 A / 230 VAC (AC11)

You will find suggestions for the dimensioning of the resistor for continuous and short term load at chapter Technical Details, pages T106E and T107E.

### Application

An important application is the use as braking resistor for motor/generator drive of motors with frequency converters where small power ratings are required. Various applications derive from the compact construction form for integration into switch cabinets.

### Special design

- Version of low inductance by bifilar winding and therefore of low-noise

### Electrical and mechanical data

Type series FZ.M.. without TS	typical power in W at 40°C, 100% DCF	production range Ω-value		dimensions in mm							approx. weight in kg
		from	up to	H	K	M	O*	R	U	X	
FZM 100x35	65	0,22	18k	77	4,5	122	140	66	44	10	0,5
FZM 135x35	100	0,33	10k	77	4,5	157	175	66	44	10	0,6
FZM 200x35	150	0,56	6,8k	77	4,5	222	240	66	44	10	0,7
FZM 330x35	250	1,0	4,7k	77	4,5	352	370	66	44	10	1,1
FZM 160x45	150	0,47	6,8k	87	5,8	186	210	75	48	10	0,7
FZM 200x45	180	0,68	5,6k	87	5,8	226	250	75	48	10	0,8
FZM 300x45	300	1,2	3,9k	87	5,8	326	350	75	48	10	1,1
FZM 200x65	300	4,7	3,9k	120	6,5	230	250	92	64	10	1,2
FZM 300x65	430	6,8	2,7k	120	6,5	330	350	92	64	10	1,7
FZM 400x65	600	10	1,8k	120	6,5	430	450	92	64	10	2,2
FZM 500x65	800	12	1,5k	120	6,5	530	550	92	64	10	2,7
FZM 600x65	1000	15	1,0k	120	6,5	630	650	92	64	10	3,3
FZZM 300x65	860	3,9	1,2k	120	6,5	326	350	185	150	10	3,4
FZZM 400x65	1200	5,6	1,0k	120	6,5	426	450	185	150	10	4,2
FZZM 500x65	1600	6,8	680	120	6,5	526	550	185	150	10	5,1
FZZM 600x65	2000	8,2	560	120	6,5	626	650	185	150	10	6,1
FZDM 300x65	1300	3,3	820	120	6,5	326	350	275	240	10	5,4
FZDM 400x65	1800	4,7	560	120	6,5	426	450	275	240	10	6,4
FZDM 500x65	2400	6,8	470	120	6,5	526	550	275	240	10	7,4
FZDM 600x65	3000	8,2	390	120	6,5	626	650	275	240	10	8,7

\* for version FZ.MQ.. dimension O is 25 mm larger  
for version FZ.M.U.. dimension O is 35 mm larger

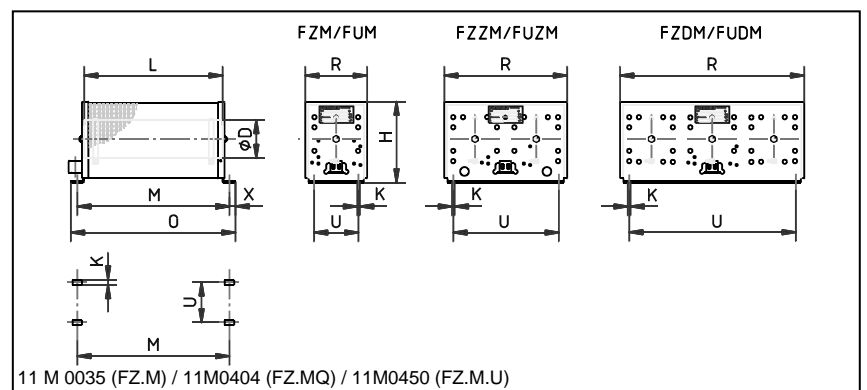

Example: Continuous dissipation 1200 W, resistance value 56 Ω with temperature switch  
Order designation: FZZMQ 400x65 – 56



Type series FZG/FZZG/FZDG

65 – 3000 W with terminal box

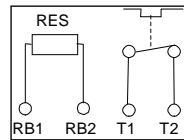

Cemented wirewound tubular fixed resistor in one- up to three-tubes design, degree of protection IP20 if mounted on an appropriate surface, with side-panels and perforated cover. Fixing parallel to mounting surface. With two connections wired on terminals in attached terminal box with PG11-cable gland.

① if mounted on an appropriate surface

**Technologies**

- version protected against access to hazardous parts
- connections at terminals up to 20A 2-poles porcelain terminal
- wall mounting or mounting on switch cabinets

**Option: temperature switch (..Q)**

This type can be equipped with a 180° C temperature switch (TS) (incl. PG9 gland) for temperature monitoring. It is wired on porcelain terminals and monitors an overloading of the resistor by a normally closed contact free of potential (NCC). This signal has to be considered by the customer e.g. by a warning or disconnection of the mains. (Restrictions please look on page T105E)

**Warning:** There will not be a disconnection of the resistor!  
Type designation then: FZ.GQ ...

Contact rating of the signal contact:

- 2 A / 24 VDC (DC11)
- 2 A / 230 VAC (AC11)

You will find suggestions for the dimensioning of the resistor for continuous and short term load at chapter Technical Details, pages T106E and T107E.

**Application**

An important application is the use as braking resistor for motor/generator drive of motors with frequency converters. Various applications derive from the compact construction form for wall mounting or mounting on a switch cabinet.

**Special design**

- Version of low inductance by bifilar winding and therefore of low noise
- up to 35 A with 2-poles flat terminals and PG13,5 cable gland (no temperature switch available)

**Electrical and mechanical data**

Type series FZ.G.. without TS	typical power in W at 40°C, 100% DCF	production range Ω-value		dimensions in mm							approx. weight in kg
				from	up to	H	K	M	O	R	
FZG 100x35	65	0,22	18k	77	4,5	160	185	66	44	10	0,6
FZG 135x35	100	0,33	10k	77	4,5	195	220	66	44	10	0,7
FZG 200x35	150	0,56	6,8k	77	4,5	260	285	66	44	10	0,8
FZG 330x35	250	1,0	4,7k	77	4,5	390	415	66	44	10	1,2
FZG 160x45	150	0,4	6,8k	87	5,8	220	249	75	48	10	0,8
FZG 200x45	180	0,6	5,6k	87	5,8	260	289	75	48	10	0,9
FZG 300x45	300	1,2	3,9k	87	5,8	360	389	75	48	10	1,2
FZG 300x65	430	6,8	2,7k	120	6,5	330	386	92	64	10	1,8
FZG 400x65	600	10	1,8k	120	6,5	430	486	92	64	10	2,3
FZG 500x65	800	12	1,5k	120	6,5	530	586	92	64	10	2,8
FZG 600x65	1000	15	1,0k	120	6,5	630	686	92	64	10	3,4
FZZG 300x65	860	3,9	1,2k	120	6,5	326	386	185	150	10	3,5
FZZG 400x65	1200	5,6	1,0k	120	6,5	426	486	185	150	10	4,3
FZZG 500x65	1600	6,8	680	120	6,5	526	586	185	150	10	5,2
FZZG 600x65	2000	8,2	560	120	6,5	626	686	185	150	10	6,2
FZDG 300x65	1300	3,3	820	120	6,5	326	386	275	240	10	5,5
FZDG 400x65	1800	4,7	560	120	6,5	426	486	275	240	10	6,5
FZDG 500x65	2400	6,8	470	120	6,5	526	586	275	240	10	7,5
FZDG 600x65	3000	8,2	390	120	6,5	626	686	275	240	10	8,8

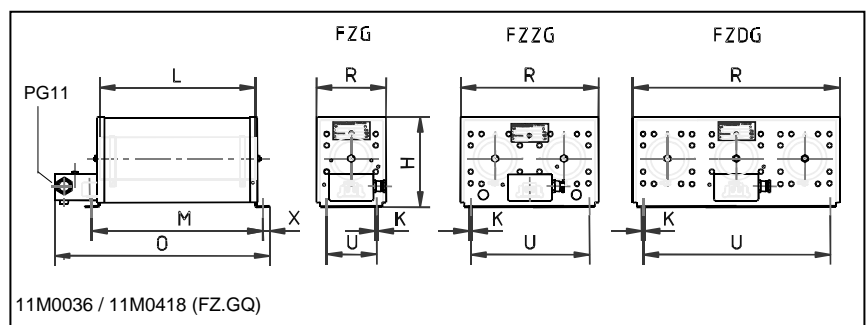

**Example of dimensioning and selection of a specific unit:**

Braking resistor for frequency converter drive with temperature switch:  
Short time dissipation 12 kW at 15% DCF, total cycle time shorter than 120 s,  
intermediate circuit voltage 650V; resistance value 33 Ω, calculating of continuous  
dissipation: 12 kW : 5 = 2,4 kW; choosen: FZDGQ 500x65 – 33

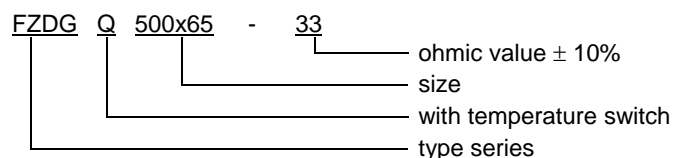





### Type series FZEC/FZCC/FZDC and FZVC/FZFC/FZSC

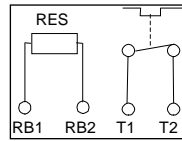
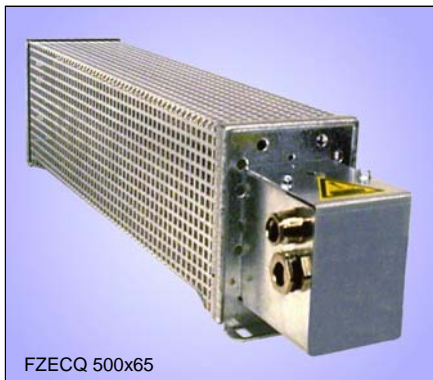

430 – 6000 W with terminal box



Cemented wirewound tubular fixed resistor in one- up to six-tube design, degree of protection IP20 if mounted on an appropriate surface, with side-panels and perforated cover. Fixing parallel to mounting surface. With two connections wired on terminals in attached terminal box with PG16-cable gland.

① if mounted on an appropriate surface

③ optional, type designation then FZ.C.U or FZ.CQU..

### Technologies

- version protected against access to hazardous parts
- connections at two-poles polyamide terminals G10/2 up to 60A
- wall mounting or mounting on switch cabinets

### Option: temperature switch (..Q)

This type can be equipped with a 180° C temperature switch (TS) (incl. M12 cable gland) for temperature monitoring. It is wired on device terminals G5 and monitors an overloading of the resistor by a normally closed contact free of potential (NCC). This signal has to be considered by the customer e.g. by a warning or disconnection of the mains.

**Warning:** There will not be a disconnection of the resistor!

Type designation then: FZ.CQ ...

Contact rating of the signal contact:

- 2 A / 24 VDC (DC11)
- 2 A / 230 VAC (AC11)

You will find suggestions for the dimensioning of the resistor for continuous and short term load at chapter Technical Details, pages T106E and T107E.

### Application

An important application is the use as braking resistor for motor/generator drive of motors with frequency converters, where medium ratings are required.

Various applications derive from the compact construction form for wall mounting or mounting on a switch cabinet.

### Special design

- version of low inductance by bifilar winding and therefore of low noise
- with cage clamp terminals 1,5/2,5/4mm<sup>2</sup>

### Electrical and mechanical data

Type series FZ.C.. without TS	typical power in W at 40°C, 100% DCF	production range Ω-value		dimensions in mm					approx. weight in kg
		from	up to	H	M	O	R	U	
FZEC 200x65	300	4,7	3,3k	120	230	349	92	64	2,0
FZEC 300x65	430	6,8	2,7k	120	330	449	92	64	2,5
FZEC 400x65	600	10	1,8k	120	430	549	92	64	3,0
FZEC 500x65	800	12	1,5k	120	530	649	92	64	3,5
FZEC 600x65	1000	15	1,0k	120	630	749	92	64	4,0
FZCC 300x65	860	3,9	1,2k	120	330	449	185	150	4,0
FZCC 400x65	1200	5,6	1,0k	120	430	549	185	150	4,9
FZCC 500x65	1600	6,8	680	120	530	649	185	150	5,8
FZCC 600x65	2000	8,2	560	120	630	749	185	150	6,7
FZDC 300x65	1300	2,7	820	120	330	449	275	240	5,5
FZDC 400x65	1800	3,3	560	120	430	549	275	240	6,7
FZDC 500x65	2400	3,9	470	120	530	649	275	240	8,0
FZDC 600x65	3000	5,6	390	120	630	749	275	240	9,2
FZVC 400x65	2400	2,7	470	210	430	549	185	150	8,7
FZVC 500x65	3200	3,3	330	210	530	649	185	150	10,3
FZVC 600x65	4000	3,9	270	210	630	749	185	150	11,9
FZFC 400x65	3000	2,2	390	210	430	549	266	240	10,9
FZFC 500x65	4000	2,7	270	210	530	649	266	240	12,9
FZFC 600x65	5000	3,3	180	210	630	749	266	240	14,9
FZSC 400x65	3600	1,8	330	210	430	549	266	240	12,3
FZSC 500x65	4800	2,2	220	210	530	649	266	240	14,6
FZSC 600x65	6000	2,7	180	210	630	749	266	240	16,9

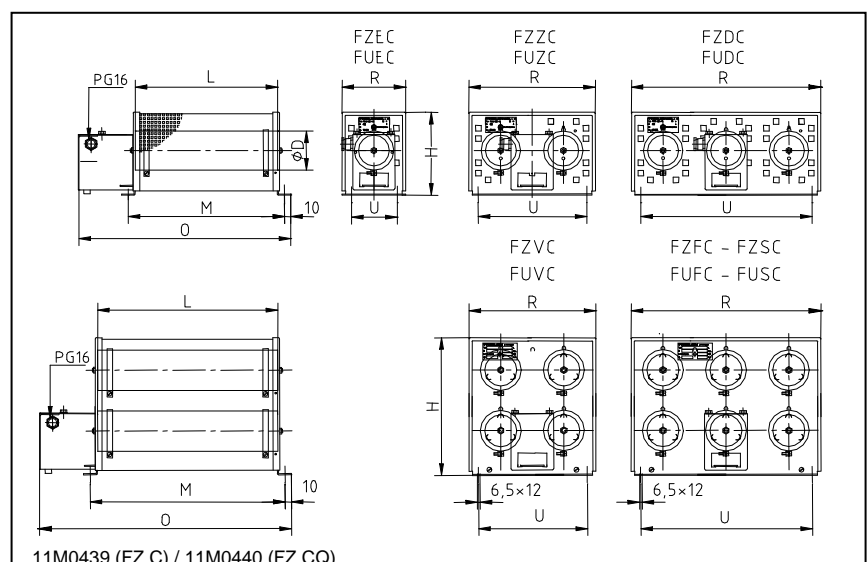





Type series FZT / FZTZ / FZDT  
and FZVT / FZFT / FZST

150 - 6000 W with thermal overload relay

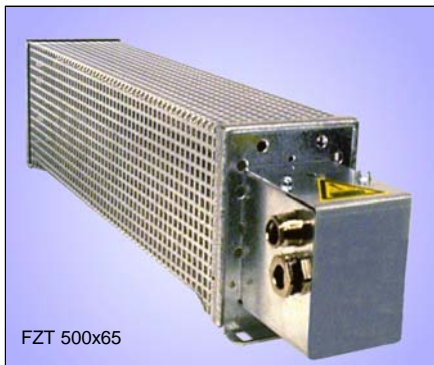

Cemented wirewound tubular fixed resistor in one- up to six-tube design, degree of protection IP20 if mounted on an appropriate surface. Connections at the integrated thermal overload relay in the attached terminal box with cable gland PG9 and PG11 (up to 13 A) or with M12 and PG16.

(>13 A or for all types in UL-version like ③)

① if mounted on an appropriate surface

③ optional for D = 65, type designation then FZ.TU

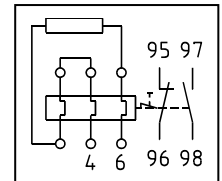

**Technologies**

- integrated thermal overload relay up to 24 A
- protection against excess temperature
- factory-made adjustment
- connections directly at the overload relay
- version protected against access to hazardous parts
- wall mounting or mounting on switch cabinets

**Thermal overload relay**

An eventual overload of the resistor is monitored by the thermal overload relay, which is mounted in the attached terminal box. This is accomplished by NCC and NOC contacts.

This warning has to be considered by the customer, e.g. by a warning or disconnection of the mains. More about operation details on page T105E.

**Warning:** There will not be a disconnection of the resistor!

**Connection cross section /screwing:**

fine stranded, for relay up to	connection in mm <sup>2</sup>	
	13A	24A
main current	1 x 2,5	2 x 6
auxiliary current	1 x 2,5	2 x 2,5
cable gland	PG9 + PG11	M12 + PG16

**Contact ratings of the signal contacts:**

- 2 A / 24 VDC (DC11)
- 2 A / 230 VAC (AC11)

**Application**

Braking resistor for motor/generator drive of motors with frequency converters. The braking current is monitored.

**Electrical and mechanical data**

Type series	typical power in W at 40°C, 100% DCF	production range Ω-value		dimensions in mm					approx. weight in kg
		from	up to	H	M	O (max.)	R	U	
FZT 160x45	150	2,2	6,8k	87	244	265	75	48	1,1
FZT 200x45	180	2,2	5,6k	87	284	305	75	48	1,2
FZT 300x45	300	3,9	3,9k	87	384	405	75	48	1,5
FZT 200x65	300	4,7	3,9k	120	230	349	92	80	2,1
FZT 300x65	430	6,8	2,7k	120	330	449	92	80	2,4
FZT 400x65	600	10	1,8k	120	430	549	92	80	2,9
FZT 500x65	800	12	1,5k	120	530	649	92	80	3,4
FZT 600x65	1000	15	1,0k	120	630	749	92	80	4,1
FZZT 300x65	860	3,9	1,2k	120	326	449	185	150	4,1
FZZT 400x65	1200	5,6	1,0k	120	426	549	185	150	4,9
FZZT 500x65	1600	6,8	680	120	526	649	185	150	5,8
FZZT 600x65	2000	8,2	560	120	626	749	185	150	6,8
FZDT 300x65	1300	2,7	820	120	326	449	275	240	6,1
FZDT 400x65	1800	3,3	560	120	426	549	275	240	7,1
FZDT 500x65	2400	4,7	470	120	526	649	275	240	8,1
FZDT 600x65	3000	5,6	390	120	626	749	275	240	9,4
FZVT 400x65	2400	4,7	470	210	426	549	185	150	9,2
FZVT 500x65	3200	5,6	330	210	526	649	185	150	11,0
FZVT 600x65	4000	8,2	270	210	626	749	185	150	13,0
FZFT 400x65	3000	5,6	390	210	426	549	266	240	11,6
FZFT 500x65	4000	8,2	270	210	526	649	266	240	13,6
FZFT 600x65	5000	10	180	210	626	749	266	240	16,1
FZST 400x65	3600	6,8	330	210	426	549	266	240	13,6
FZST 500x65	4800	10	220	210	526	649	266	240	15,6
FZST 600x65	6000	12	180	210	626	749	266	240	18,6

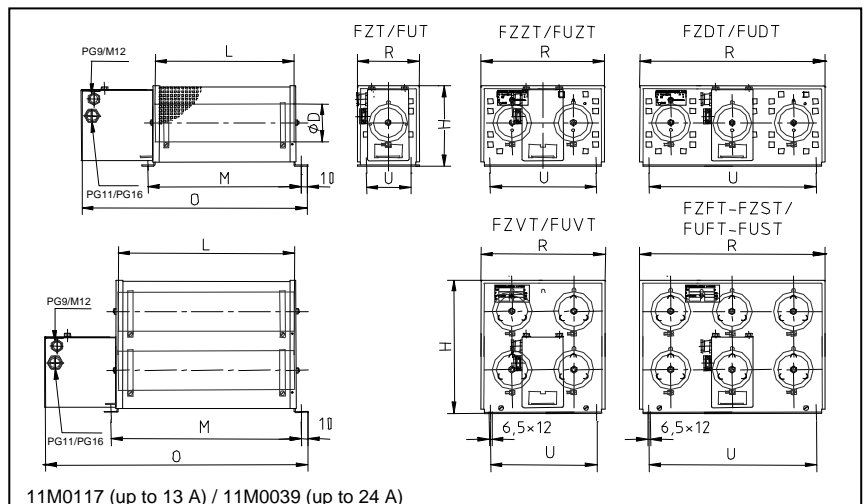

11M0117 (up to 13 A) / 11M0039 (up to 24 A)



Type series FZEX / FZZX / FZDX  
and FZVX / FZFX / FZSX

300 - 6000 W – intrinsically safe

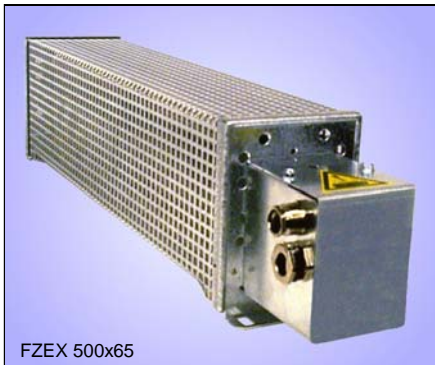

Cemented wirewound tubular fixed intrinsically safe resistor in one- up to six-tube design, degree of protection IP20 if mounted on an appropriate surface. Connections at the integrated FRIZLEN DC-POWERSWITCH<sup>④</sup> in the attached terminal box with cable gland PG9 and PG11 (up to 16 A) or with M12 and PG16-cable gland (>16 A). Switch off by overload.

- ① if mounted on an appropriate surface
- ③ optional, type designation then FZ.XU... - in progress
- ④ German patented design no. DGBM 20 2009 015 851.9

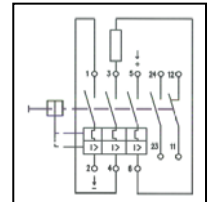

### Technologies

- intrinsically safe resistor
- attention: only suitable for DC voltage up to 850 VDC
- integrated FRIZLEN DC-POWERSWITCH up to 25 A
- switch off by overload
- factory adjusted
- connection directly at the FRIZLEN DC-POWERSWITCH
- protected against access to hazardous parts
- wall mounting or mounting on switch cabinets

### Intrinsically safe resistor through FRIZLEN DC-POWERSWITCH

These type series with overload switch is able to protect the integrated resistors from constant overload and from too high short time peak power, e.g. caused by a false operational mode or a fault by an short circuited chopper transistor.

This option for protection not only signals the hardware fault, it switches off the object / the resistor absolutely reliable! Possible damage in the environment by overheating and burning are effectively avoided. The actual fault is reported by potential free N/O and N/C contacts. After a successful fault clearance the DC-POWERSWITCH can be switched on like a normal automatic cutout.

### Connection cross section /screwing:

fine stranded, up to	connection in mm <sup>2</sup>
main current	2,5 mm <sup>2</sup> - 10 mm <sup>2</sup> (AWG 14 – AWG 8)
auxiliary current	1,5 mm <sup>2</sup>

### Contact ratings of the signal contacts:

- 5 A / 24 VDC (DC11)
- 10 A / 230 VAC (AC11)

### Electrical and mechanical data

Type series	typical power in W at 40°C, 100% DCF	production range Ω-value		dimension in mm					approx. weight in kg
		von	bis	H	M	O	R	U	
L x D									
FZEX 200x65	300	4,7	3,9k	120	230	405	92	80	2,4
FZEX 300x65	430	6,8	2,7k	120	330	505	92	80	2,7
FZEX 400x65	600	10	1,8k	120	430	605	92	80	3,2
FZEX 500x65	800	12	1,5k	120	530	705	92	80	3,7
FZEX 600x65	1000	15	1,0k	120	630	805	92	80	4,4
FZZX 300x65	860	3,9	1,2k	120	326	505	185	150	4,4
FZZX 400x65	1200	5,6	1,0k	120	426	605	185	150	5,2
FZZX 500x65	1600	6,8	680	120	526	705	185	150	6,1
FZZX 600x65	2000	8,2	560	120	626	805	185	150	7,1
FZDX 300x65	1300	2,7	820	120	326	505	275	240	6,4
FZDX 400x65	1800	3,3	560	120	426	605	275	240	7,4
FZDX 500x65	2400	3,9	470	120	526	705	275	240	8,4
FZDX 600x65	3000	5,6	390	120	626	805	275	240	9,7
FZVX 400x65	2400	3,9	470	210	426	605	185	150	9,5
FZVX 500x65	3200	5,6	330	210	526	705	185	150	11,3
FZVX 600x65	4000	6,8	270	210	626	805	185	150	13,3
FZFX 400x65	3000	5,6	390	210	426	605	266	240	11,9
FZFX 500x65	4000	6,8	270	210	526	705	266	240	13,9
FZFX 600x65	5000	8,2	180	210	626	805	266	240	16,4
FZSX 400x65	3600	6,8	330	210	426	605	266	240	13,9
FZSX 500x65	4800	8,2	220	210	526	705	266	240	15,9
FZSX 600x65	6000	10	180	210	626	805	266	240	18,9

